

Article number: 437900038

Description: Rota-fix shaft-hub connection SA 38

## Measures

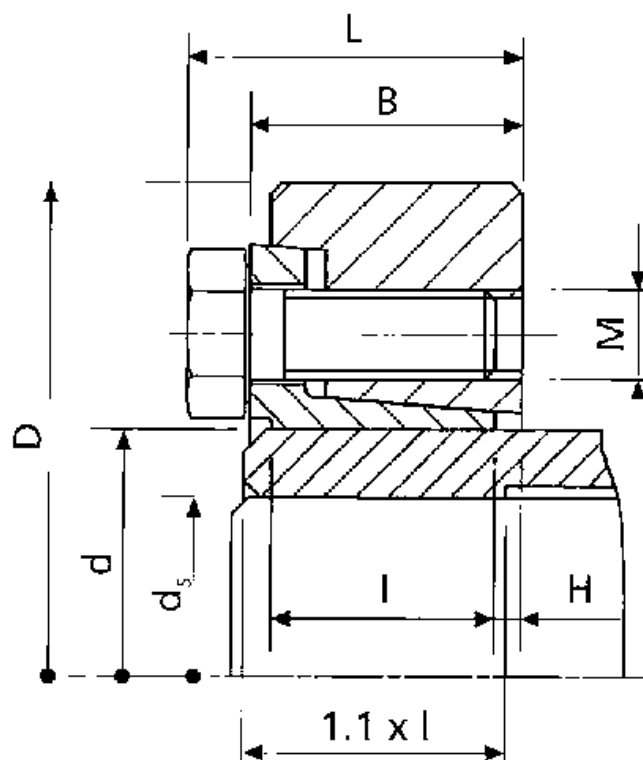

B mm	= 22.0	M mm	= M8
d H8 mm	= 38	T N m torque	= 480
D mm	= 72.0	Ts N m bolt tightening torque	= 30
ds mm	= 27		
F kN torque	= 36		
H	= 2.0		
I mm	= 19.0		
L mm	= 27.5		